

# BOXER 15

## AIR-OPERATED DOUBLE DIAPHRAGM PUMPS

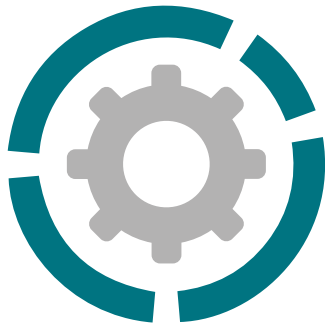

**DEBEM**  
MADE IN ITALY



Suction / delivery connections	3/8" f BSPP (*)
Air fitting	3/8" f BSPP
Max flow rate*	17 l/min
Max supply air pressure	8 bar
Max head*	80 m
Max negative suction head - dry running**	3 m
Max negative suction head - pump primed	9,5 m
Max diameter suspended solids	0,5 mm
Noise level	65 dB
Volume per stroke	10,3 cc



(\*) NPT fittings only on request

\* The curves and performances refer to pumps with immersed suction and open delivery outlet with water at 20 °C and vary according to the composition materials.

\*\* Value depends on pump configuration.

CE



- Product designed and constructed in Italy
- PATENTED stall-prevention pneumatic circuit
- Operates with NON-lubricated air
- SELF-PRIMING
- Supports dry running
- ATEX certification for ZONE 1 - ZONE 2
- IECEx certification
- Adjustable operating speed
- Versatile
- Suitable for pumping fluids with high viscosity and for demanding applications
- Usable with fluids containing suspended solids
- Option of suspended installation
- Manifolds available with stainless steel reinforcement rings for PP - PP + CF - PVDF pumps
- Suitable for continuous use

# BOXER 15

AIR-OPERATED DOUBLE DIAPHRAGM PUMPS



## Specifications and types



ATEX Zona 1 (CONDUCT): II2GExhIIIBT4Gb – II2DExhIIIBT135°CDBx  
 ATEX Zona 2 (STANDARD): II3GExhIIIBT4Gc – II3DExhIIIBT135°CDCx – IM2ExhIMbX\*  
 IECEx: ExhIIIBT4Gb – ExhIIIBT135°CDB

\* The string relating to mining applications is not applicable to aluminium BOXER range pumps



PP

Boxer 15



### Maximum Dimensions

Height	149 mm
Width	148 mm
Depth	80 mm



### Construction materials (body and manifolds) and net weight

Polypropylene (with glass filler)	1,1 Kg
	Temp. 3°C min. 65°C max
Conductive polypropylene (with carbon filler)	1,1 Kg
	Temp. 3°C min. 65°C max



PVDF

Boxer 15



### Maximum Dimensions

Height	149 mm
Width	149 mm
Depth	80 mm



### Construction materials (body and manifolds) and net weight

PVDF (with carbon filler)	1,38 Kg
	Temp. 3°C min. 95°C max

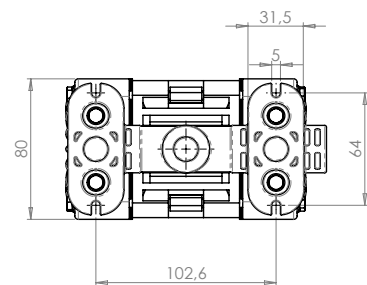
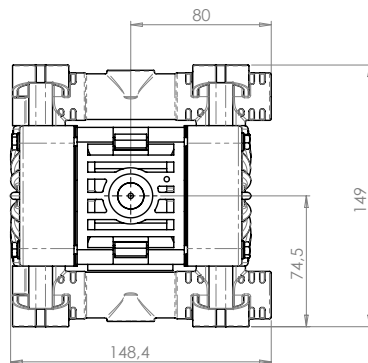
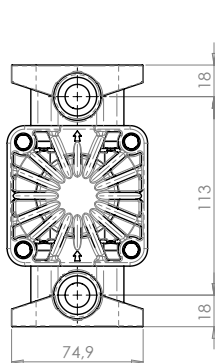

# BOXER 15

AIR-OPERATED DOUBLE DIAPHRAGM PUMPS



## Specifications and types



ATEX Zona 1 (CONDUCT): II2GExhIIIBT4Gb – II2DExhIIIBT135°CDBX  
 ATEX Zona 2 (STANDARD): II3GExhIIIBT4Gc – II3DExhIIIBT135°CDCX – IM2ExhIMbX\*  
 IECEx: ExhIIIBT4Gb – ExhIIIBT135°CDB

\* The string relating to mining applications is not applicable to aluminium BOXER range pumps



### ALU

Boxer 15

#### Maximum Dimensions

Height	151 mm
Width	149 mm
Depth	80 mm

#### Construction materials (body and manifolds) and net weight

ALU	1,9 Kg Temp. 3°C min. 95°C max
-----	--------------------------------------

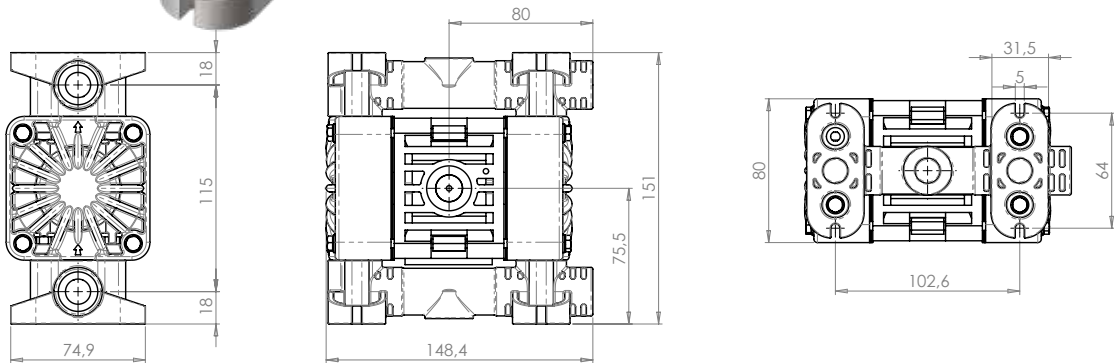

### AISI 316 L

Boxer 15

#### Maximum Dimensions

Height	141 mm
Width	153 mm
Depth	80 mm

#### Construction materials (body and manifolds) and net weight

AISI 316 L	2,4 Kg Temp. 3°C min. 95°C max
------------	--------------------------------------

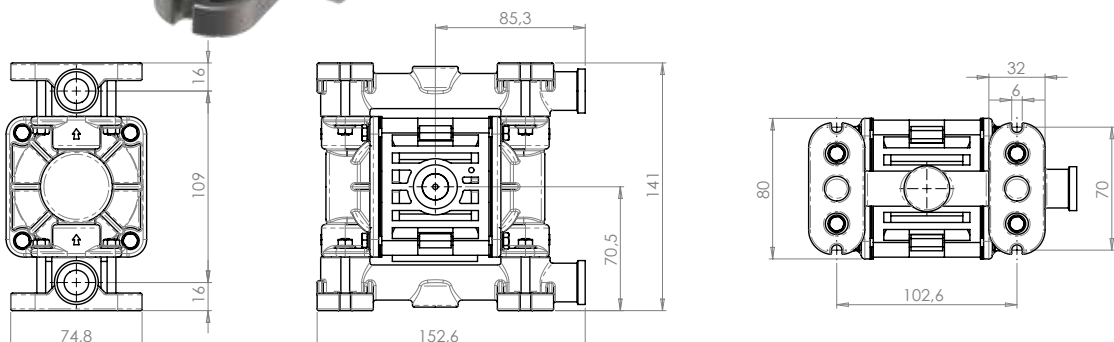

# BOXER 15

## AIR-OPERATED DOUBLE DIAPHRAGM PUMPS



### Specifications and types



ATEX Zona 1 (CONDUCT): II2GExhIIIBT4Gb - II2DExhIIIBT135°CDBX  
 ATEX Zona 2 (STANDARD): II3GExhIIIBT4Gc - II3DExhIIIBT135°CDCx - IM2ExhIMbX\*  
 IECEx: ExhIIIBT4Gb - ExhIIIBT135°CDB

\* The string relating to mining applications is not applicable to aluminium BOXER range pumps

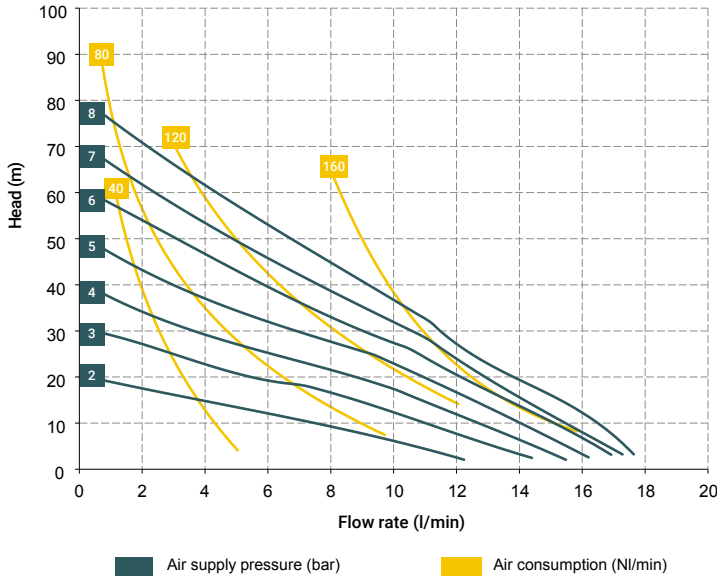

\* The curves and performances refer to pumps with immersed suction and open delivery outlet with water at 20 °C and vary according to the composition materials.

#### Accessories:

- Equaflux 51
- (For damper materials, please refer to the technical data sheet)
- Foot valve
- Air regulation kit
- Batch controller
- Stroke counter
- Reinforcement rings
- Flange kit (DIN flanges - ANSI on request)

#### T15 distributor material (compressed air circuit):

- POM

#### Core material:

- Polypropylene (with glass filler)
- Conductive polypropylene (with carbon filler)
- Aluminium

#### Diaphragm materials:

- PTFE
- NBR

#### Cap materials:

- Polypropylene (with glass filler)
- Conductive polypropylene (with carbon filler)
- PVDF
- PPS
- Natural ECTFE
- AISI 316 L

#### Ball materials:

- PTFE
- AISI 316 L
- EPDM

#### O-ring materials:

- EPDM
- NBR
- VITON®
- PTFE

#### Packaging:

cardboard box - 14 x 20 x 20 cm - weight 0.4 kg  
 (the weight refers only to the packaging without the pump inside)

Any colour variations in our polypropylene and PVDF products are due to the special blends of the raw materials used. The use of high levels of glass and long-fiber carbon filler result in a unique colour that does not in any way affect the quality of the product; on the contrary, it points to the high level of content used to ensure outstanding performance.

#### BOXER 15 (PP):

A1 - A2 - A4 - A5 - A6 - M1 - M2- M4 - M5 - M6

#### BOXER 15 (PVDF):

A1 - A2 - A4 - A5 - A6 - M1 - M2- M4 - M5 - M6

#### BOXER 15 (INOX):

A1 - A2 - A4 - A5 - A6 - M1 - M2- M4 - M5 - M6

#### BOXER 15 (ALU):

A1 - A2 - A4 - A5 - A6 - M1 - M2- M4 - M5 - M6

#### Standard fittings:

- Suction:  
A1
- Delivery:  
M1



# BOXER 15

AIR-OPERATED DOUBLE DIAPHRAGM PUMPS



## Specifications and types



ATEX Zona 1 (CONDUCT): II2GExhIIBT4Gb – II2DExhIIBT135°CDbX  
 ATEX Zona 2 (STANDARD): II3GExhIIBT4Gc – II3DExhIIBT135°CDcX – IM2ExhIMbX\*  
 IECEx: ExhIIBT4Gb – ExhIIBT135°CDb

\* The string relating to mining applications is not applicable to aluminium BOXER range pumps

## BOXER PUMPS CODES ENCODING

ex. IB15-P-HTTPV--

Internal distributor, Boxer 15, body PP, air-side diaph. Hytrel®, product-side diaph. PTFE, AISI 316 L balls, PP ball seats, EPDM O-Ring.

IB15-	P	H	T	T	P	V	-	-
PUMP MODEL	PUMP BODY	AIR-SIDE DIAPHRAGM	FLUID-SIDE DIAPHRAGM	BALLS	BALL SEATS	O-RING	MANIFOLD	VERSION
<b>IB07</b> - Boxer 07 <b>IB15</b> - Boxer 15 <b>IMICR</b> - Microboxer <b>IB35</b> - Boxer 35 <b>IB50</b> - Boxer 50 <b>IMIN</b> - Miniboxer <b>IB81</b> - Boxer 81 <b>IB90</b> - Boxer 90 <b>IB100</b> - Boxer 100 <b>IB150</b> - Boxer 150 <b>IB251</b> - Boxer 251 <b>IB252</b> - Boxer 252 <b>IB522</b> - Boxer 522 <b>IB502</b> - Boxer 502 <b>IB503</b> - Boxer 503	<b>P</b> - PP <b>PC</b> - PP+CF <b>FC</b> - PVDF+CF <b>A</b> - AISI 316 (L) <b>AL</b> - ALU	<b>N</b> - NBR <b>D</b> - EPDM <b>H</b> - Hytrel® <b>M</b> - Santoprene®	<b>T</b> - PTFE	<b>T</b> - PTFE <b>A</b> - AISI 316 L <b>D</b> - EPDM <b>N</b> - NBR	<b>P</b> - Polypropylene <b>F</b> - PVDF <b>A</b> - AISI 316 L <b>I</b> - PE-UHMW <b>R</b> - PPS <b>L</b> - Aluminium	<b>D</b> - EPDM <b>V</b> - Viton® <b>N</b> - NBR <b>T</b> - PTFE	<b>X*</b> <b>3*</b> <b>Y*</b> <b>W*</b> <b>K*</b>	<b>C*</b> <b>Z*</b>

Example table, for the table with the complete codes please contact the Debem sales department.

\*X = split manifold

\*3 = 3rd hole on the manifold

\*Y = manifold with NPT fitting

\*W = clamp manifold

\*K = manifold with reinforcement rings  
(all on request only)

C = CONDUCT version for ATEX ZONE 1

Z = Version for IECEx Standard

### SELF-PRIMING USE



### UNDER HEAD USE



### DRUM TRANSFER



### SPLIT SUCTION and DELIVERY



### SPLIT SUCTION



## MAIN APPLICATION SECTORS

