





## Model POST

IT 	GB 	FR 	E 	DE 
<b>Protezione fissa</b>	<b>Fixed guard</b>	<b>Protecteur fixé</b>	<b>Protección fija</b>	<b>Schutzvorrichtung befestigt</b>
1.0 Introduzione 2.0 Dati tecnici 3.0 Installazione 4.0 Funzionamento/uso 5.0 Certificazione 6.0 Identificazione 6.1 Controllo qualità 7.0 Manutenzione 8.0 Cond.di stoccaggio 8.1 Smaltimento 9.0 Disegno+Esploso 10.0Esempio di montaggio	1.0 Introduction 2.0 Technical Data 3.0 Installation 4.0 Operation and use 5.0 Certification 6.0 Identification 6.1 Quality control 7.0 Maintenance 8.0 Storage conditions 8.1 Disposal 9.0 Design and detailed view 10.0 Example of assembly	1.0 Présentation 2.0 Données techniques 3.0 Installation 4.0 Fonctionnement et emploi 5.0 Certification 6.0 Identification 6.1 Le contrôle de qualité 7.0 Entretien 8.0 Condition de stockage 8.1 Bélimination 9.0 Plan et explosé 10.0Exemple de montage	1.0 Introducción 2.0 Datos técnicos 3.0 Instalación 4.0 Funcionamiento y utilización 5.0 Certificación 6.0 Identificación 6.1 Control de calidad 7.0 Mantenimiento 8.0 Condiciones de almacenamiento 8.1 Disposición 9.0 Plano de despiece 10.0Ejemplo de montaje	1.0 Einführung 2.0 Technische Daten 3.0 Installation 4.0 Betrieb und Nutzung 5.0 Zertifizierung 6.0 Identifizierung 6.1 Qualitätskontrolle 7.0 Wartung 8.0 Lagerbedingungen 8.1 Entsorgung 9.0 Zeichnung und explodierte Bild 10.0Montage Beispiel

1.0 Introduzione	1.0 Introduction	1.0 Presentation	1.0 Introduccion	1.0 1.0 Einführung
La protezione fissa è destinata ad essere integrata in una macchina utensile.	The fixed guard is designed for integration into a machine tool.	La protection fixé est destinée à être intégrée sur sur une machine-outil	La protección fija está destinada a ser integrada en una máquina herramienta.	Diese befestigt Schutzvorrichtung ist dazu bestimmt, auf einer Werkzeugmaschine.

2.0 Dati tecnici	2.0 Technical data	2.0 Données techniques	2.0 Datos técnicos	2.0 Technische Daten
Spessore Policarbonato: <b>4mm</b> Spessori acciaio:15/10 Peso: <b>5Kg</b>	Polycarbonate thickness: <b>4mm</b> <b>thickness</b> steel : <b>15/10</b> <b>Weight :5kg</b>	Épaisseur polycarbonate : <b>4m</b> <b>m Acier</b> épais : <b>15/10</b> <b>Poids:5kg</b>	Groso policarbonato: <b>4mm</b> <b>Acero grueso:15/10</b> Peso: <b>5kg</b>	Stärke Polycarbonat: <b>4mm</b> <b>Dicke Stahl :15/10</b> <b>Gewicht :5 kg</b>
3.0 Installazione	3.0 Installation	3.0 Installation	3.0 Instalación	3.0 Installation
Il sollevamento del riparo può avvenire a mano.  La protezione deve essere fissata mediante viti M6 (non fornite).	The guard can be lifted by hand.  The guard must be secured with M6 screws (not provided).	Le levage du protecteur peut être exécuté manuellement.  La protection doit être fixée à l'aide de vis M6 (non fournies) .	La manipulación de la protección puede realizarse a mano .  La protección debe fijarse mediante tornillos M6 (no suministrados) .	Das Hochheben der Schutzeinrichtung kann per Hand erfolgen.  Sie ist mit M6 Schrauben (nicht im Lieferumfang) .
N°4 Fori di fissaggio	4 off fixing holes	N°4 Trous de montage	N°4 Orificios de montaje	N°4 Befestigungslöcher

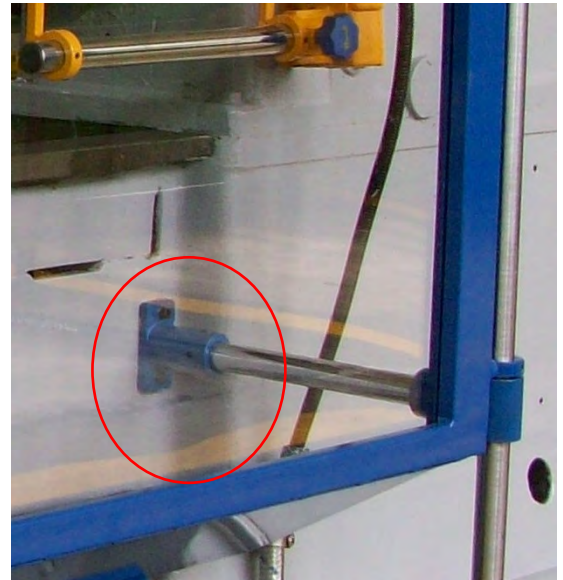
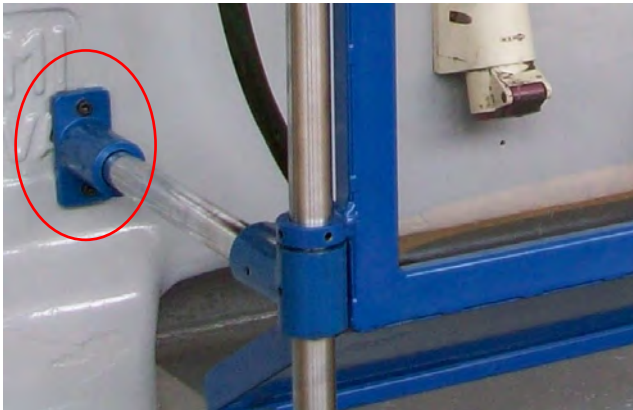

**SINCE 1970**





# Repar2

**MACHINE GUARDS**

3.0	3.0	3.0	3.0	3.0

4.0 Funzionamento ed uso	4.0 Operation and use	4.0 Fonctionnement et emploi	4.0 Funcionamento y utilizacion	4.0 Betrieb und Nutzung
<p>Il riparo è destinato ad essere utilizzato su una macchina utensile.</p> <p>E' severamente vietato rimuovere la protezione. Sotto riportato il simbolo che indica il divieto di rimozione applicato sulla protezione.</p>	<p>The guard is designed for use on machine tools</p> <p>It is strictly forbidden to remove the guard. This is indicated by the symbol attached to the screen.</p>	<p>Le protecteur est destiné à être utilisé sur une machine-outil.</p> <p>Il est strictement interdit d'enlever la protection. Le symbole indiquant l'interdiction appliquée à la suppression de la protection.</p>	<p>La protección está destinada a utilizarse en una máquina herramienta similar.</p> <p>Está estrictamente prohibido quitar la protección. Este símbolo indica la prohibición expresa de la retirada de la protección.</p>	<p>Die Schutzeinrichtung ist auf Werkzeugmaschinen zu verwenden.</p> <p>Es ist strengstens verboten, die Sicherheitsvorrichtung außer Kraft zu setzen. Hier unten finden Sie das auf der Vorrichtung angelegte Verbot-Piktogramm.</p>



5.0 Certificazione 	5.0 Certification 	5.0 Certification 	5.0 Certification 	5.0 Zertifizierung 
<b>DICHIARAZIONE CE DI CONFORMITA' FORNITA CON LA PROTEZIONE</b> Con riferimento alle seguenti norme armonizzate: <b>EN ISO 12100:2010</b> <b>EN ISO 14120:2015</b> <b>EN ISO 14119:2013</b>	<b>CE DECLARATION OF CONFORMITY</b> SUPPLIED WITH GUARD with regard to the following harmonised standards: <b>EN ISO 12100:2010</b> <b>EN ISO 14120:2015</b> <b>EN ISO 14119:2013</b>	<b>DÉCLARATION CE DE CONFORMITÉ-FORNI AVEC LA PROTECTION</b> En ce qui concerne les normes harmonisées suivantes : <b>EN ISO 12100:2010</b> <b>EN ISO 14120:2015</b> <b>EN ISO 14119:2013</b>	<b>DECLARACIÓN CE DE CONFORMIDAD SUMINISTRADA CON LA PROTECCION</b> Con referencia a las siguientes normas armonizadas: <b>EN ISO 12100:2010</b> <b>EN ISO 14120:2015</b> <b>EN ISO 14119:2013</b>	<b>EG Konformitätserklärung</b> mit der Vorrichtung geliefert  Bezug nehmend auf die folgenden harmonisierten Normen: <b>EN ISO 12100:2010</b> <b>EN ISO 14120:2015</b> <b>EN ISO 14119:2013</b>

6.0 Identificazione	6.0 Identification	6.0 Identification	6.0 Identificacion	6.0 Identifizierung
------------------------	-----------------------	-----------------------	-----------------------	------------------------

Targhetta identificativa	Identification plate	Plaque de identification	Placa del fabricante	Typenschild
--------------------------	----------------------	--------------------------	----------------------	-------------



6.1 Controllo qualità	6.1 Quality control	6.1 Le controle de qualite	6.1 Control de calidad	6.1 Qualitätskontrolle
--------------------------	------------------------	-------------------------------	---------------------------	---------------------------

STRUTTURA	STRUCTURE	STRUCTURE	ESTRUCTURA	AUFBAU	
SCHERMO	SCREEN	ÉCRAN	PANTALLA	SCHIRM	
SUPPORTO	SUPPORT	SOUTIEN	SOPORTE	HALTERUNG	
VITERIA	SCREWS	VIS	TORNILLOS	SCHRAUBEN	

7.0 Manutenzione	7.0 Maintenance	7.0 Entretien	7.0 Mantenimiento	7.0 Wartung
Operazione di pulizia: Acqua e Sapone	Clean with water and soap.	Nettoyage: L'eau et du Savon	Limpieza: Agua y Jabón	Reinigung: Wasser und Seife
Verifica delle integrità e del serraggio	Verify the integrity and tightness of all fixing screws.	La vérification de l'intégrité et de serrer	Compruebe periodicament el correcto funcionamiento	Überprüfen dass die Gewindestifte, die das Schutzschirm am Tragarm befestigen nicht beschädigt oder locker sind.
In caso di riparazione apporre: <b>Macchina non in sicurezza</b>	In case of malfunction, isolate the machine following lock-out / tag-out procedure.	En cas d'apposer de réparation: <b>La machine n'est pas sécuritaire</b>	<b>En caso de reparación pendiente: La máquina no es segura</b>	<b>Im Fall von Reparaturen: das Schild „Maschine nicht sicher“ anbringen</b>

<b>8.0</b> <b>Condizioni di stoccaggio</b>	<b>8.0</b> <b>Storage conditions</b>	<b>8.0</b> <b>Condition de stockage</b>	<b>8.0</b> <b>Condiciones de almacenamiento</b>	<b>8.0</b> <b>Lagerbedingungen</b>
Lasciare la protezione nel sacchetto protettivo	Store guard in protective bag until required.	Laisser protection dans un sac de protection	Deja la protección en la bolsa protectora del embalaje original	Lassen Sie Schutz in Schutztasche

<b>8.1</b> <b>Smaltimento</b>	<b>8.1</b> <b>Disposal</b>	<b>8.1</b> <b>Élimination</b>	<b>8.1</b> <b>Disposición</b>	<b>8.1</b> <b>Entsorgung</b>
Prima di effettuare operazioni di smaltimento dei componenti che costituiscono il prodotto, consultare il fabbricante, che indicherà le modalità operative nel rispetto dei principi di sicurezza e di <b>salvaguardia ambientale</b> . Il prodotto può essere <b>smaltito senza bisogno di ridurlo in pezzi minuti</b> ; è sufficiente scollegare i principali gruppi che la compongono e porli sul mezzo di trasporto adibito alla rottamazione. Provvedere al loro smaltimento operando in conformità alle norme vigenti, rivolgendosi agli organismi preposti e/o ad imprese specializzate nella rottamazione e/o nello smaltimento dei rifiuti, affinché avvenga la separazione tra materiale plastico, materiale metallico e componenti che devono essere inviati a raccolte differenziate. È obbligo del datore di lavoro essere a conoscenza delle leggi vigenti in merito nel proprio paese e operare in modo da ottemperare a tali legislazioni. È vietato ed inoltre passibile di sanzioni, abbandonare il prodotto nell'ambiente	Before you dispose of the components that make up the product, contact the manufacturer, who will be able to advise you regarding methods that comply with local environmental regulations. The product can be disposed of without being broken into small parts. Simply disassemble the main groups and bring them to waste collection. Dispose of them in compliance with current regulations, using agencies and/or firms specializing in scrapping and/or waste disposal, so that plastic material, metallic material and components that must be sent to the waste collection are separated. It is the responsibility of the employer to be aware of the laws in force in the country and comply with such legislation. It is also prohibited and punishable by law to leave the product in the environment.	Avant d'effectuer l'élimination des éléments qui composent le produit, contactez le fabricant, qui indiquera les modes de fonctionnement en conformité avec les principes de sécurité et de protection de l'environnement. Le produit peut être éliminé sans avoir besoin de le casser en petits morceaux: il suffit de débrancher les principaux groupes qui le composent et de les amener aux moyens de transport utilisés pour la destruction. Éliminer les faire fonctionner en conformité avec la réglementation en vigueur, s'adressant aux agences et / ou des entreprises spécialisées dans la mise au rebut et / ou de l'élimination des déchets, ainsi que la séparation entre la matière plastique, matériau métallique et des composants qui doivent être transmis à la collecte des déchets . Il appartient à l'employeur de connaître les lois en vigueur dans leur pays et sur le travail afin de se conformer à ces lois. Il est également interdit et passible de sanctions, laissez le produit dans l'environnement	Antes de llevar a cabo la eliminación de los componentes que conforman el producto, póngase en contacto con el fabricante, que le indicará los métodos de funcionamiento de conformidad con los principios de seguridad y protección del medio ambiente. El producto puede ser eliminado sin necesidad de dividirlo en partes más pequeñas: simplemente desconecte los principales grupos que la componen y lívelos a los medios de transporte utilizados para la destrucción. Deshágase de ellos en cumplimiento de la normativa vigente, dirigiéndose a los organismos y / o empresas especializadas en el desguace y / o eliminación de residuos, de forma que la separación entre el material plástico, material metálico y los componentes que debe enviarse a la recogida de residuos . Corresponde al empresario estar al tanto de las leyes vigentes en su país y sobre el trabajo con el fin de cumplir con dicha legislación. Le recordamos también que está prohibido y castigado penalmente, arrojar el producto al medio ambiente.	Bevor die Bauelemente der Schutzeinrichtung entsorgt werden, sollte man deren Hersteller befragen, um gemäß der Sicherheits- und <b>Umweltschutznormen</b> zu vorgehen. Es ist nicht nötig die Einrichtung abzubrechen. Man braucht nur die wichtigsten Baugruppen abzutrennen und sie auf einem LKW oder einem anderen Mittel zur Verschrottung zu laden. Die Entsorgung soll gemäß der geltenden Normen durch in Verschrottung und Entsorgung spezialisierte Firmen erfolgen, die in der Lage sind, Kunststoff, Metalle oder andere Materialien gut zu sammeln und zu trennen. Dem Arbeitgeber müssen die Richtlinien in Kraft in eigenem Land bewusst sein und er muss gemäß diese Rechtsvorschriften handeln. Es ist auch verboten und mit Strafen bedroht, das Produkt in die Umwelt abzugeben.

9.0 Esploso	9.0 Exploded View	9.0 Schema	9.0 Plano de despiece	9.0 Explosionszeichnung
----------------	----------------------	---------------	--------------------------	----------------------------

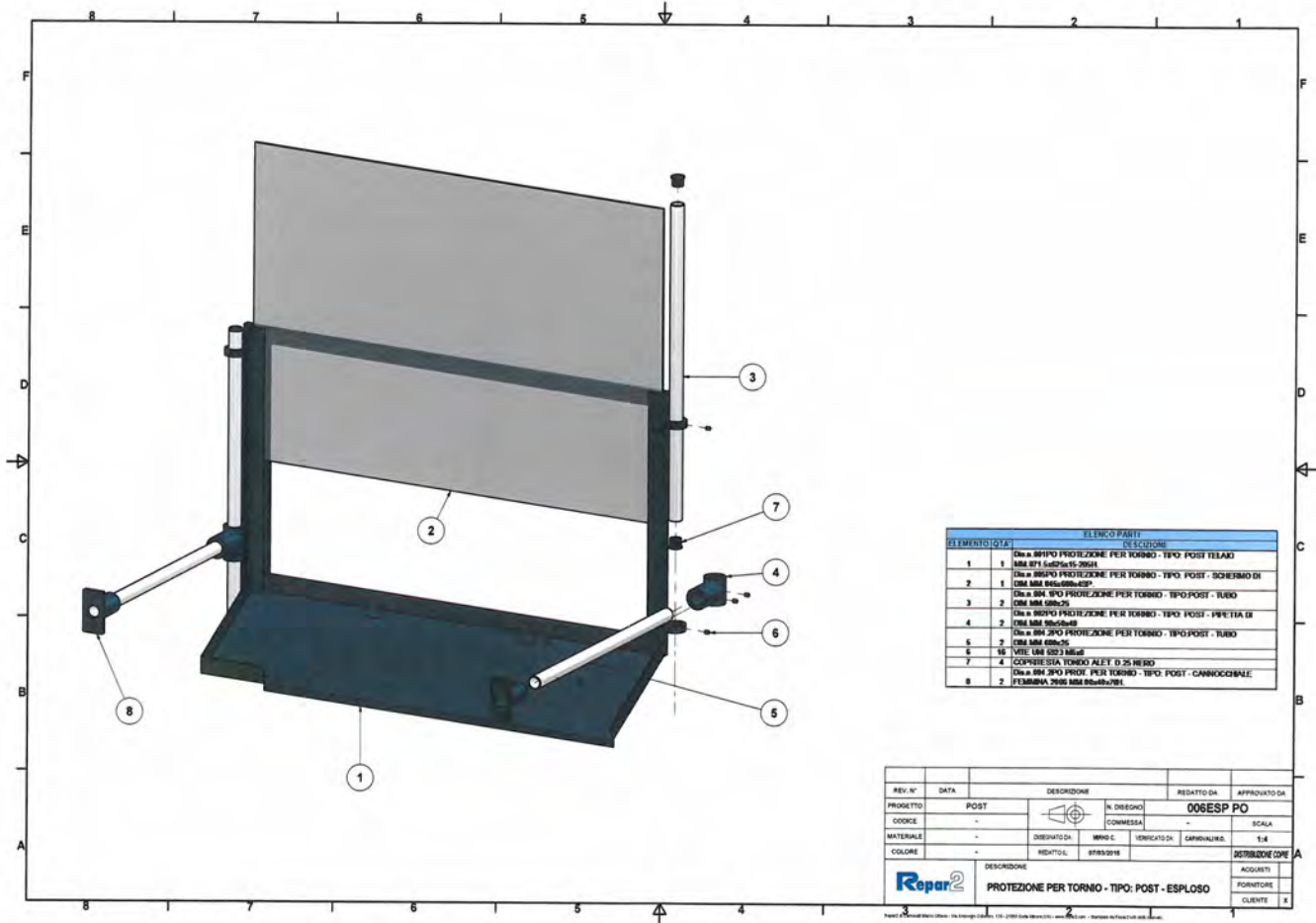

10.0 Esempio di montaggio	10.0 Example of assembly	10.0 Exemple de montage	10.0 Ejemplo de montaje	10.0 Montage Beispiel
------------------------------	-----------------------------	----------------------------	----------------------------	--------------------------





di **Carnovali Marco Ottavio** Via Ambrogio Colombo, 176- 21055 Gorla Minore (VA) – Italy  
 www.repar2.com -info@repar2.com Tel:+39 0331 465727 Fax:+39 0331 465728  
 Exp.Dept: exportoffice@repar2.com

**UCIMU-SISTEMI PER PRODURRE**  
 MEMBER COMPANY

Distributore	Distributor	Distributeur	Distribuidor	Händler
--------------	-------------	--------------	--------------	---------

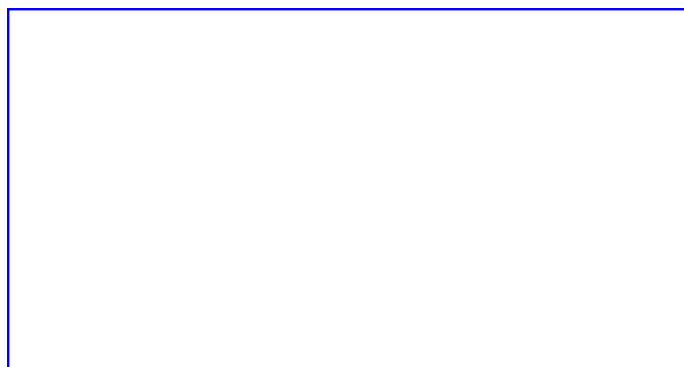

MANUALE DELLE ISTRUZIONI PER L'USO	MANUAL OF INSTRUCTIONS FOR USE	MANUEL D'INSTRUCTIONS POUR L'UTILISATION	MANUAL DE INSTRUCCIONES DE USO	BEDIENUNGSANLEITUNG
<p>N. volumi: 1            Data: Revisione: 00            ©Copyright 2013 – REPAR2</p> <p>Senza la preventiva autorizzazione scritta della REPAR2 questo manuale o parte di esso non può essere riprodotto in nessuna forma, modificato, trascritto, tradotto in qualsiasi lingua, reso disponibile a terzi o comunque usato in modo che possa pregiudicare gli interessi della REPAR2. <b>Ogni abuso sarà perseguito</b> ai sensi di legge e sui diritti d'autore.</p>	<p>N. volumes: 1            Date: Revision: 00            © Copyright 2013 - REPAR2</p> <p>Without the prior written permission of REPAR2, this manual or any part of it may not be reproduced in any form, edited, transcribed, translated into any language, made available to third parties or used in a manner that is likely to affect the interests of REPAR2. Any violation will be prosecuted according to law and copyright.</p>	<p>N. volumes: 1            Date: Révision: 00            © Copyright 2013 - REPAR2</p> <p>Sans l'autorisation écrite préalable de REPAR2 ce manuel ou toute partie de celle-ci ne peut être repro-duit sous quelque forme que modifié, transcrite, traduite dans une autre langue, mis à la disposi-tion des tiers ou utilisées d'une manière qui est susceptible d'affecter les intérêts de la REPAR2 Toute infraction sera pour-suivie conformément à la loi et le droit d'auteur.</p>	<p>N. volúmenes: 1            Fecha: Revisión: 00            © Copyright 2013 - REPAR2</p> <p>Sin la previa autorización por escrito de REPAR2 este manual o cualquier parte del mismo no puede ser reproducido en cualquier forma, editar, transcribir, traducir a ningún idioma, poner a disposición de terceros ni utilizados de manera que pueda afectar a los intereses de REPAR2 Cualquier violación de éstas normas será perseguida de acuerdo con la ley y los derechos de autor.</p>	<p>Nr. Volumen: 1            Datum: Revision: 00 © Copyright 2013 - REPAR2</p> <p>Es ist strengstens verboten, diese Anleitung oder Teile davon ohne schriftliche Genehmigung von REPAR2 in keiner Form zu vervielfältigen, ändern, transkribieren, in irgendeiner Sprache übersetzen oder zur Verfügung von Dritten zu stellen oder sie auf eine Weise zu benutzen, dass die Interessen der REPAR2 beeinträchtigt werden. Jeder Verstoß wird nach dem Gesetz und Urheberrecht verfolgt werden.</p>